



improve your life

CE

EN

MILO INVERTER SUPERSILENT

PORTABLE AIR CONDITIONER (LOCAL)



OPERATING INSTRUCTIONS

Read the instructions carefully before operating the appliance or carrying out maintenance work. Observe all the safety instructions; failure to do so may lead to accidents and/or damage. Store these instructions in a safe place for future reference.



Appliance is filled with flammable gas R290.

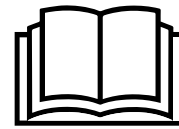

Before installing and using the appliance, read the owner manual.



Before installing the appliance, read the installation manual.



Any repairs you need, contact the nearest authorized Service Centre and strictly follow manufacturer's Service Manual.

THE REFRIGERANT R290

- To realize the function of the air conditioner unit, a special refrigerant circulates in the system. The refrigerant is the fluoride R290 - GWP (Global warming potential): 0,02. This refrigerant is flammable and inodorous. It can lead to explosions under certain conditions, however the flammability of this refrigerant is very low and it can be ignited only by fire.
- Compared to other common refrigerants, R290 is a non-polluting refrigerant with no harm to the ozonosphere and a no effect upon the greenhouse effect. R290 has very good thermodynamic features which lead to a really high energy efficiency. The units therefore need less filling.

Warning:

Do not try to accelerate the defrosting process or to clean the appliance in different ways other than those recommended by the manufacturer.

Should repair be necessary, contact your nearest authorized Service Centre.

Any repairs carried out by unqualified personnel may be dangerous.

The appliance has to be stored in a room that doesn't have any continuously operating ignition sources. (for example: open flames, an operating gas appliance or an operating electric heater.)

Do not pierce or burn.

Appliance has to be installed, used and stored in a room with a floor area larger than 10 m².

The appliance contains flammable R290 gas.

Attention, refrigerants have no smell.



GENERAL OPERATING AND SAFETY INSTRUCTIONS

- This appliance is a local air conditioner designed for domestic use.
- Only use this air-conditioner as described in this manual.
- Ensure that the required voltage and frequency (220-240V~/50Hz) match the available power source.
- Fuse style 50CT, 50CT(P), UDA, UDA-A, 5H, 524, TSC, TSC+P; the electricity passing through the fuse cannot be above 15A.
- This appliance can be used by children aged from 8 years and above and people with reduced physical, sensory or mental capabilities or lack of experience and knowledge if they have been given supervision or instruction concerning use of the appliance in a safe way and understand the hazards involved.
- Children shall not play with the appliance.
- Cleaning and user maintenance shall not be made by children without supervision.
- Ensure that the electricity system is able to deliver the operating current required by the air conditioner, in addition to that normally absorbed by other appliances (household appliances, lighting system, etc.). Please refer to the maximum power input data indicated on the air conditioner's data plate.
- Connection to the electricity grid must take place in accordance with current installation standards.
- Ensure that the automatic switches and system protection valves are able to withstand a start-up current of 6A (normally for less than 1 second).
- The system socket must always be fitted with an efficient earth connection.
- Make sure that the plug is fully inserted. Do not use multiple adapters. Do not touch the plug with wet hands. Make sure that the plug is clean.
- Do not use the plug as a means by which to start/stop the air conditioner: use the ON/OFF button on the remote control or on the control panel.
- Do not install the air conditioner in rooms where it may receive water splashes (e.g. laundry rooms).
- This air conditioner can be used by children of 8 years of age or older, and by persons with reduced physical, sensory and mental abilities or who lack the necessary know-how and experience to operate it, if under the supervision or instruction of a person responsible for their safety, so that they are fully aware of the attendant risks.

- Before moving or cleaning the device, ensure that it is unplugged from the socket.
- Do not move the air conditioner while it is operating; first turn the appliance off, check for any condensate build-up and empty it if necessary.
- To turn the appliance off, set the remote control to OFF and remove the plug from the socket. Pull on the plug only. Do not pull the cord.
- **Do not use the appliance if the cord or plug are damaged.** If the power supply cord is damaged, it must be replaced by the manufacturer, dealer or a similarly qualified person so as to avoid any safety risks.
- Keep the unit away from fire, possible fire sources, inflammable or explosive objects.
- Do not leave the unit unattended while it's operating, turn the unit off and unplug it.
- If drainage hose is used, the ambient temperature mustn't be lower than 0 °C. It can cause water leakage to the air conditioner.
- Do not splash or pour water on the air conditioner

PRECAUTION!

- **Do not insert any objects into the air conditioner: this is very dangerous as the fan turns at high speed.**
- **Ensure that air circulates freely around the unit. Do not cover the air intake and delivery grilles with drapes or any other means.**

WARNING!

- The air conditioner must be positioned **at least 50 cm** from the wall or any other obstacles, on a flat and stable surface so as to avoid water leaks.
- **The air conditioner is fitted with a system for protecting the compressor from overload. This means that the compressor only starts 3 minutes after its previous stoppage.**
- **Please wait at least 3 minutes before starting the unit. This helps prevent the compressor from being damaged.**

WARNING!

- **In the event of an anomaly, switch the appliance off and unplug it from the socket. Do not dismantle or attempt to repair or modify the In the**

event of a malfunction, contact the service centre directly.

WARNING!

- Do not expose the air conditioner to direct sunlight, as the colour of the materials may change; moreover, the appliance may overheat causing the protection mechanism to intervene and switch the appliance off.
- Do not use insecticides, oils, detergents or spray paints near the appliance; do not use aggressive chemical detergents to clean the casing: this may damage the finish and colour.
- Close all open windows to maximise air conditioning efficiency.

The manufacturer will not be held liable if safety and accident prevention rules are not observed.

DESCRIPTION OF THE APPLIANCE

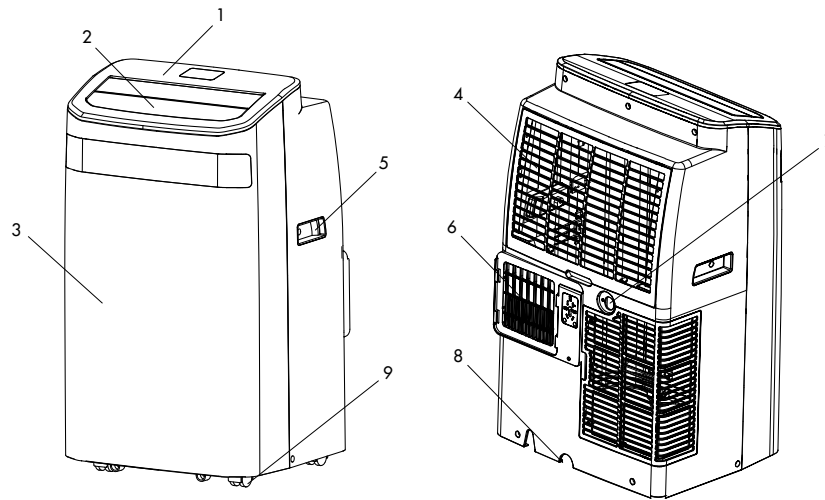

1. Control panel
2. Adjustable air louver
3. Front panel
4. Air intake with filter
5. Handle

6. Air outlet hose
7. Continuous drain outlet (dehumidification mode)
8. Drain outlet (cooling mode)
9. Castors

Min/max operating limits (internal temperature)

Cooling: 16 °C B.S./35 °C B.S.

Dehumidification: 17 °C B.S./35 °C B.S.

Heating: 5 °C B.S./27 °C B.S.

Cooling mode room temperature adjustment range: 16 °C B.S./32 °C B.S.

PRE-OPERATING CHECKS AND OPERATIONS

The following space must be maintained to ensure the operating efficiency of the portable air conditioner.

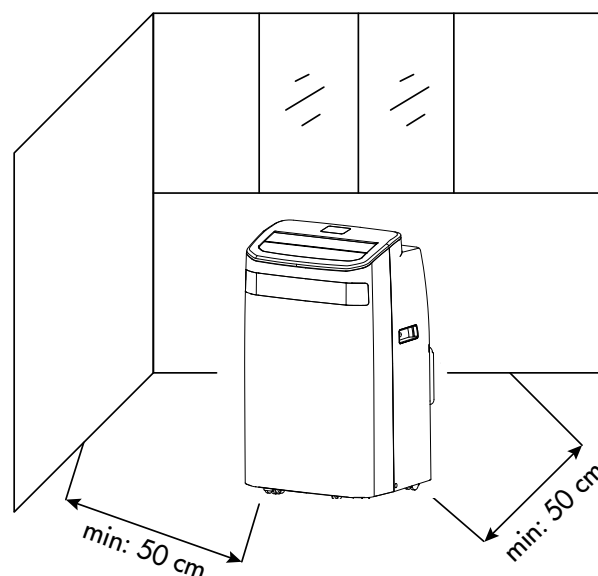

APPLIANCE START UP

Open the packaging and pull out the box. Remove the product and the other elements supplied (illustrated in the box below).

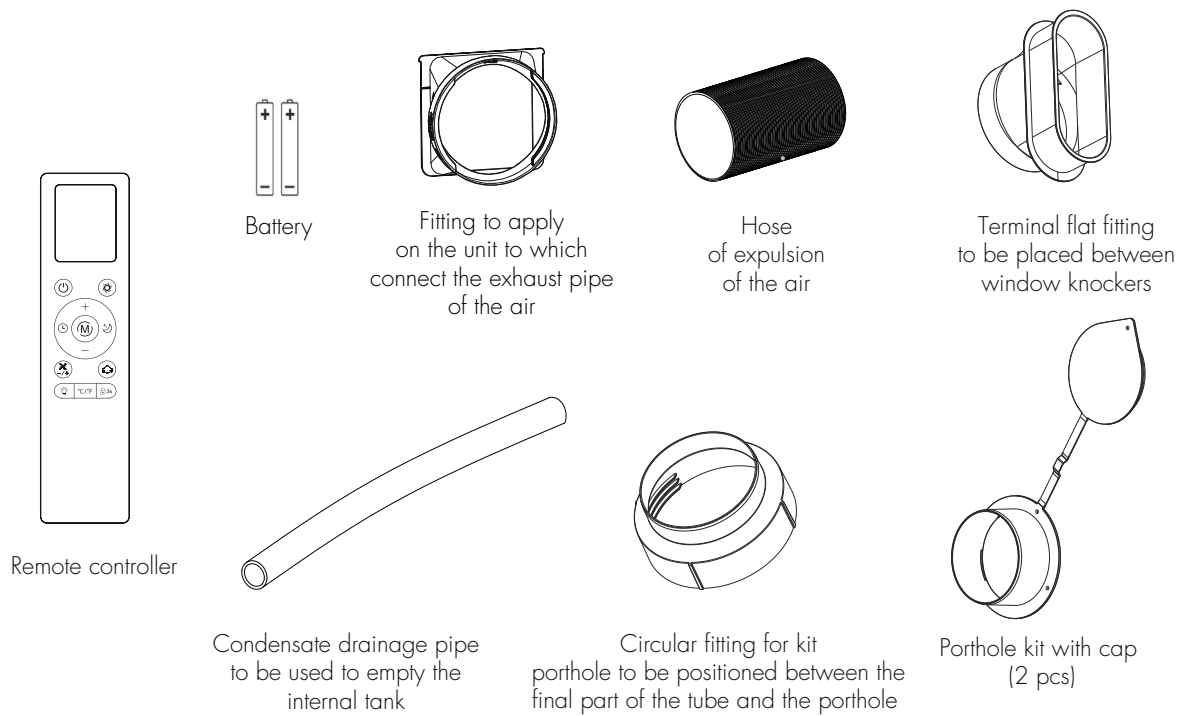

USE WITH END FITTING FOR WINDOW

1. Connect the flat fitting to the hose, extend the hose as maximum (1,5 mt) for reaching the outside and it connect to the back of the air conditioner. (Fig. 1)
2. Open the windows and lock one of the two leaves with the handle. Place the end fitting against the fixed leaf of the window, and draw the other leaf towards it. (Fig. 2)

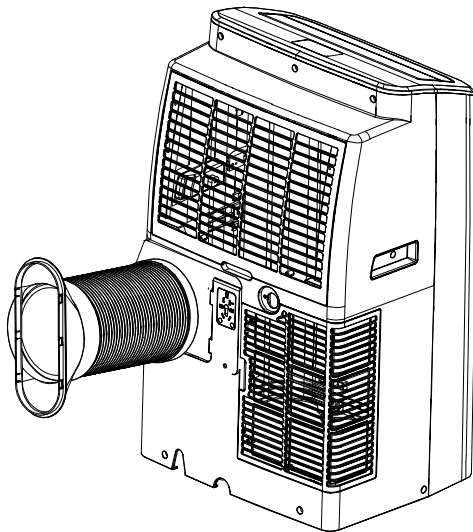

Fig. 1

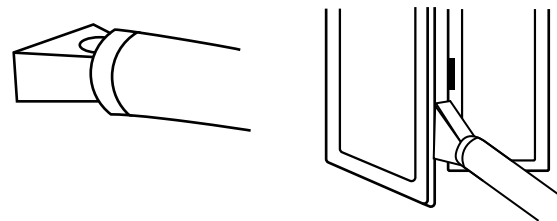
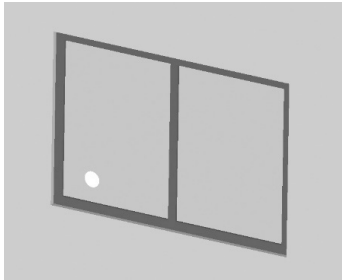

Fig. 2

USE WITH WINDOW UNIT KIT

1. To make the hole in the glass it is advisable to take the porthole kit accessory to the glazier (Fig. 1)
2. Insert the window unit into the window (Fig. 2)
3. Insert the round fitting into the retractable flexible pipe and insert the latter with its round fitting into the window unit without the plug (Fig. 3)
4. During periods of non-use, disconnect the hose and close the door with the cap (Fig. 4)



(Fig. 1)

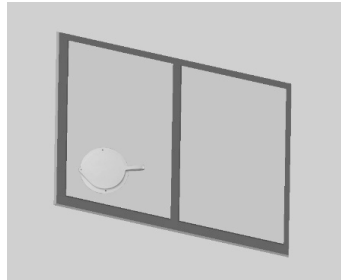

(Fig. 2)

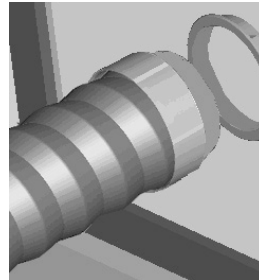

(Fig. 3)

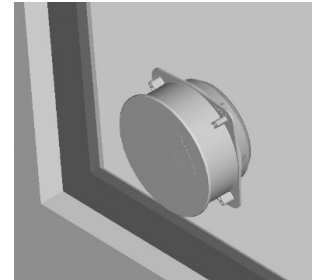

(Fig. 4)

Avoid tight curves or bends in the flexible hose. The hose, once fully extended, must be positioned at a height higher than the hose attachment point on the machine, approximately between 40 and 160 cm to ensure the correct height that does not compromise the performance of the air conditioner.

If the air conditioner is not used for prolonged periods, disconnect the pipe and plug the window unit.

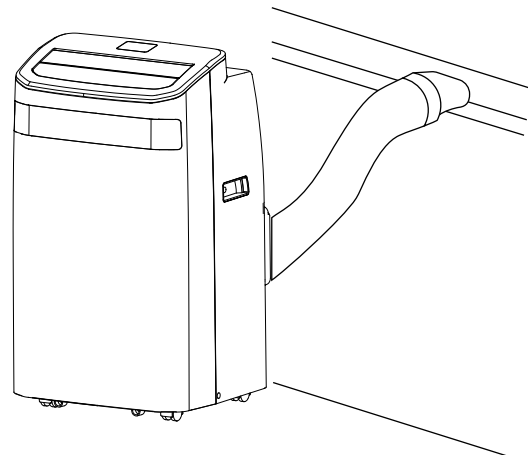
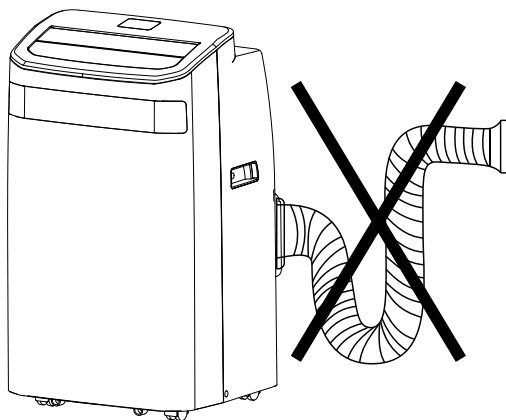

HOW TO USE THE APPLIANCE

This appliance can be used for Cooling, Heating, Dehumidification and Fan. Before using the appliance, leave it in an upright position for at least two hours.

Plug the power cord into an appropriate power outlet (220-240~V). Insert the supplied battery into the remote controller, observing the polarities. Select the desired operating mode from the remote controller.

The air conditioner is equipped with a protection system which causes the unit to activate in Cooling, Heating, Dehumidification and Heating mode only after an interval of approximately 3 minutes from the selection. Even when passing from one mode to another, the fan continues to operate, but the compressor stops to restart after 3 minutes. This start delay protects the compressor from overload.

This appliance is equipped with an automatic defrosting system which intervenes when the unit is running hot and ice forms on the coil. When the appliance starts defrosting, the Power LED flashes on the control panel. The compressor stops for 10 minutes, after which the appliance resumes normal operation.

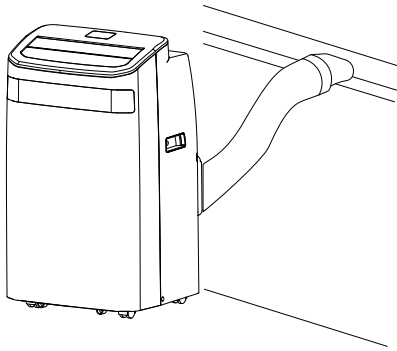

Cooling, Heating, Fan

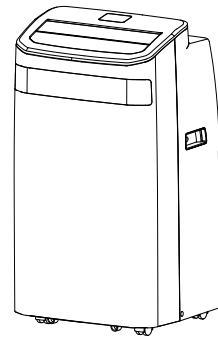

Dehumidifying

THE DISCHARGE TUBE MUST ALWAYS BE CONNECTED to the appliance: the only exception is when the appliance is used solely for dehumidification, in which case it is advisable to let the appliance discharge directly into the environment for maximum efficiency (consult the "Dehumidification Mode" paragraph).

Regularly clean the air filter to keep the air conditioner working efficiently.

OPERATING MODES

1. COOLING MODE

- Press the MODE button to select the cooling mode. The LED  on the control panel will turn on.
- Press the UP/DOWN buttons on the control panel to select the desired temperature, which will appear on the control panel display.
- The temperature adjustment range is from 16°C to 32°C.
- In this mode it is possible to adjust the ventilation speed (Fan Speed), set the vertical oscillation of the louvers with the SWING button, set the Timer and the SLEEP function.
- For quieter operation, reduce the speed to minimum (low).

2. HEATING MODE

- Press the Mode button on the control panel to select the Heating mode. The LED  on the control panel lights up.
- Press the UP/DOWN buttons on the control panel to select the desired temperature, which will appear on the control panel display.
- The temperature adjustment range is from 16°C to 32°C.
- In this mode it is possible to adjust the ventilation speed (Fan Speed) and set the Timer and the SLEEP function.
- For quieter operation, reduce the speed to minimum (low)

3. DEHUMIDIFICATION MODE

- Press the MODE button to select the Dehumidification mode. The LED  on the control panel lights up.
- The temperature is controlled by the electronic board and cannot be adjusted.
- The fan speed is fixed at low and cannot be adjusted.

NOTE

The air conditioner does not cool the room when operating as a dehumidifier.

When the appliance is used as a dehumidifier, the flexible pipe must not be connected.

For maximum dehumidification efficiency, **leave the rear discharge attachment free to discharge directly into the environment.**

The dehumidification mode is recommended during autumn and winter.

If used during summer, it is best to leave the flexible pipe attached so that the hot air is discharged towards the outside rather than into the room.

During dehumidification, continuous drainage should be implemented (see the next chapter, "HOW TO ELIMINATE CONDENSATE").

4. FAN MODE

- Press the MODE button to select the Ventilation mode. The LED  on the control panel lights up.
- In this mode it is possible to adjust the ventilation speed (Fan speed).
- The temperature cannot be adjusted.

HOW TO ELIMINATE CONDENSATE

This appliance automatically vaporizes condensation in **Cooling**. When the air conditioner operates in Cooling mode, it is not necessary to have continuous condensate drainage; only in particular climatic conditions in which the air humidity rate is very high can water deposit inside the unit.

In **Heating** the condensate is not vaporised automatically, it will therefore be necessary to empty the tank. It is recommended to arrange continuous drainage of condensation from the lower hole. **The display will show the message "Ft"**, signaling that filling has taken place and blocking the operation of the appliance.

Cooling and Heating

This appliance automatically vaporizes condensation only in Cooling. Make sure that, when the unit operates in Cooling or Heating, the rubber caps that close the drain holes on the back are correctly positioned.

When the air conditioner operates in Cooling or Heating, it is not necessary to have continuous condensate drainage. In Cooling mode and only in particular climatic conditions in which the air humidity rate is very high, water may deposit inside the unit.

When the tank is full, the display shows the message "Ft" signaling that it has been filled and blocking the operation of the appliance. To empty the tank, turn off the air conditioner and unplug it. Remove the plug from the bottom drain hole and place the end over a regular drain.

Make sure the hose is free from twists and bends. The pipe must have a downward trend. Close the drain with the cap and resume using the air conditioner.

In Heating mode, the condensate is not vaporized and flows into the internal tank, which once filled stops the operation of the appliance. To prevent this from happening, it is suggested to arrange continuous condensation drainage from the lower hole, taking care to position the unit on a small rise in order to ensure the necessary slope for the drainage pipe.

Dehumidification

Warning: when using the air conditioner in **dehumidification mode**, it is **advisable to always set up continuous drainage** to ensure maximum dehumidification efficiency. Connect one end of the PVC tubing (provided) to the top drain hole and the other end above a drain.

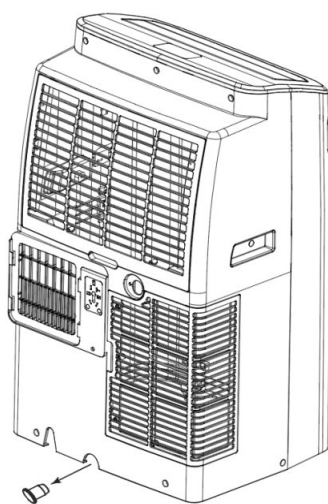

Hole closing cap

Manual drainage
(Cooling, Heating)

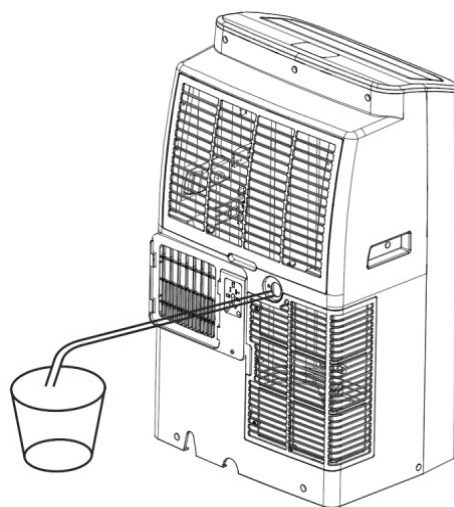

Continuous drainage
(Dehumidification)

FUNCTION CONTROL

BY REMOTE CONTROLLER

How to insert batteries into the remote control

1. Insert the batteries into the remote control, while respecting the indicated polarities.
2. Only use type AAA 1.5V batteries.
3. Remove the batteries if the remote control is not used for a month or longer.
4. Do not attempt to recharge the batteries. Replace all batteries at the same time.
5. Do not throw the batteries into fire: they may explode.

WARNINGS FOR BATTERIES

Batteries must not be exposed to heat sources such as fire, sun or similar; remove batteries if they start to heat up or if you know that you are not using the appliance for a long time, batteries must be properly installed in the battery compartment;

- when you remove the batteries because at the end of life or damaged, dispose of them according to the current national regulations and below.
- in case of loss of battery fluid, remove all batteries, preventing the spilled liquid from touching the skin or clothing. If the liquid from the battery comes into contact with the skin or clothing, wash the skin with water immediately. Before inserting new batteries, thoroughly clean the battery compartment with a paper towel cloth, or follow the battery manufacturer's recommendations for cleaning.

Warning: explosion hazard if battery is replaced with incorrect type. Use and replace only batteries with the same size and type. Improper use of batteries can cause liquid leakage, overheating or explosion. This liquid is corrosive and can be toxic. It can cause skin and eye burns, and is harmful to swallow.

To reduce the risk of injury:

- Keep batteries out of the reach of children.
- Do not heat, open, drill, cut or throw batteries into the fire.
- Do not mix old and new batteries or batteries of different types
- Do not leave metal objects that may come into contact with the battery terminals and thus may heat up and/or cause burns.



INFORMATION FOR THE CORRECT DISPOSAL OF BATTERIES IN ACCORDANCE WITH REGULATION (EU) 2023/1542

Replace batteries when they are depleted. At the end of their life, batteries must be disposed of separately from unsorted waste. They must be taken to designated recycling centres or returned to a retailer providing this service. Separate disposal of batteries prevents potential negative effects on the environment and human health due to inadequate disposal, and also allows for recovering and recycling their constituent materials, resulting in significant savings in terms of energy and resources. The separate disposal obligation is underlined by the crossed-out dustbin symbol appearing on the battery. Illegal disposal of the product by the user implies administrative sanctions applied as per current regulations.

FOR OPTIMUM OPERATION OF THE REMOTE CONTROL, ADDRESS THE TRANSMITTER HEAD TOWARDS THE RECEIVER LOCATED ON THE AIR CONDITIONER.

CONTROL BY REMOTE CONTROLLER

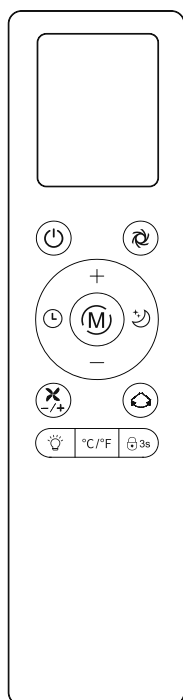

Button	Function
	Press this button to turn on/off the unit.
	Press this button to activate the timer.
	Press this button to cycle through the operation modes: Cool, Dry, Fan and Heat.
	Press this button to activate Sleep Mode.
	Press this button to turn on/off oscillation.
	Press this button to turn the LED display on/off.
	Press this button to select the fan speed: High, Medium, or Low. Speed Indicators: LEDs on the display will illuminate to show the selected fan speed.
	Press this button to activate the lock function. When activated, all functions are disabled. Press and hold for 3 seconds to unlock.
	Press this button to toggle the temperature display between Fahrenheit and Celsius.
	Press this button to turn on/off Strong Cooling Mode (high fan speed, 16°C).

CONTROL BY CONTROL PANEL

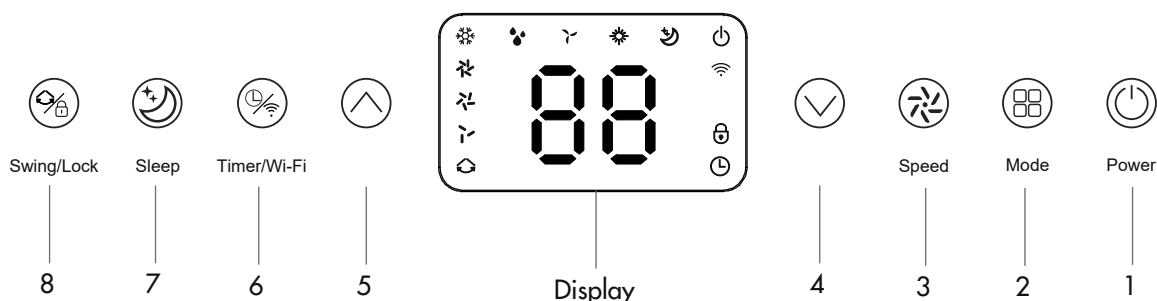

- 1. POWER button
- 2. MODE button
- 3. SPEED button
- 4. DOWN button
- 5. UP button
- 6. TIMER/WIFI button
- 7. SLEEP button
- 8. SWING/LOCK button

1. POWER BUTTON

Press this button on the control panel or remote controller to turn the unit on or off. When turned on, the appliance will start to operate in ventilation mode by default, then press the Mode button on the remote controller or on the control panel to select the desired operating mode.

2. MODE BUTTON

Press this button to select the different operating modes, according to this sequence: Cooling -> Dehumidification -> Fan -> Heating

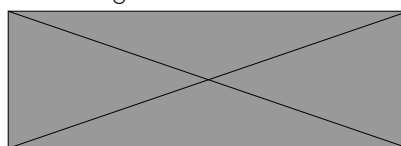

The corresponding LEDs light up on the control panel depending on the selection made.

3. FAN SPEED BUTTON

Press this button on the control panel or remote controller to adjust the fan speed in the following circular sequence: high, medium, low.

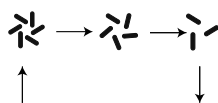

The LEDs on the control panel light up according to the selected speed.
The fan speed cannot be adjusted in DRY mode and is fixed at low.

4. UP BUTTON

5. DOWN BUTTON

Press UP/DOWN buttons on the control panel to adjust the temperature (1 °C steps) and set the Timer (each time the buttons are pressed the adjustment step is 1 hour up to 24 hours).

The temperature can be adjusted from 16°C to 32°C.

6. TIMER BUTTON

Press this button on the control panel or remote controller to set the unit's On or Off Timer, the adjustment range is from 1 to 24 hours.

On Timer: When the air conditioner is off, press TIMER to set a time to turn on the unit. Press the UP/DOWN buttons on the control panel or + - button on the remote controller to set the time.

Off Timer: When the air conditioner is on, press TIMER to set the time to turn off the unit. Press UP/DOWN on the control panel or + - button on the remote controller to set the time.

To cancel the Timer function, press the UP/DOWN buttons repeatedly, 00 will appear on the display.

When the air conditioner is turned off with the Power button, the Timer function is cancelled.

WIFI FUNCTION

To activate or deactivate the Wifi function, press and hold the Timer/Wifi button on the control panel to begin configuration. The LED  on the control panel lights up.

For Wifi configuration, refer to the dedicated paragraph.

7. SLEEP BUTTON

Press the Sleep button on the remote controller or control panel to activate the Sleep function when the unit is operating in Cooling or Heating mode.

In Cooling: after the first hour the set temperature increases by 1 °C, after the second hour it increases again by 1 °C.

In Heating: after the first hour the temperature decreases by 1 °C, after the second hour it decreases again by 1 °C.

The temperature is then kept constant for 12 hours, all LEDs on the control panel turn off. The ventilation speed decreases to minimum to ensure silence during the night hours, and it is not possible to adjust it.

8. SWING/LOCK BUTTON

Press this key to turn on or off the horizontal louver swing.

Long press this button to activate or deactivate the control panel lock (child lock).

DISPLAY OF TEMPERATURE °C / °F

Press this button on the remote controller to change the temperature display from °C to F°.

AUTOMATIC DEFROST FUNCTION

If the ambient temperature is low, frost may form on the evaporator during operation. The unit will automatically begin defrosting and the POWER LED on the control panel will flash. The defrost sequence is as follows:

- When the unit operates in cooling or dehumidifying mode, the room temperature sensor detects that the evaporator temperature is below -1°C, then the compressor stops operating for 10 minutes until it reaches the temperature of 7°C, then the unit continues to operate in cooling mode.
- When the unit operates in heating or dehumidification mode, if the temperature sensor detects that the evaporator temperature is less than 40°C and if the temperature difference between the evaporator temperature and the room temperature is less than 19° C, the compressor runs for 20 minutes, the unit starts defrosting for 5 minutes and the POWER LED on the control panel will flash.

OVERLOAD PROTECTION FUNCTION

In the event of a forced power failure, the unit resumes operation after 3 minutes to allow the compressor to restart.

TEMPERATURE DISPLAY AND ERRORS

With the exception of message P1, tank full, when an error occurs do not attempt to repair the air conditioner, always take it to an Argoclima Assistance Centre, otherwise the guarantee will no longer be valid.

Problem	Cause	Solution
E0	Communication faults between main PCB and display PCB.	Contact a service centre.
E1/E3	Failure of room temperature sensor.	Contact a service centre.
E2	Failure of temperature sensor on the evaporator.	Contact a service centre.
E4	Failure of sensor to check the compressor pipe temp	Contact a service centre.
Ft	Alarm of full water tank.	Connect the PVC pipe to the condensate drain hole and empty the water tank.

WIFI GUIDE

INFORMATION ON THE "SMART LIFE" APP

The "Smart Life" App is available for Android and iOS. Scan the corresponding QR code to directly access the download.



Smart Life App download

INFORMATION ON USING THE APP

- The presence of an integrated wifi module allows you to manage the functions of the device via the home network.
- The prerequisites are a permanent Wi-Fi connection to the home modem and the free "Smart Life" app.
- Download and install the "Smart Life" App on your smartphone or tablet. Create your account and log in
- Activate the WIFI function on the device.
- Place the device at a distance of approximately 5 meters from the router.
- Long press the Timer button to start the network setup, when the WIFI indicator flashes, you can connect the WIFI

WIFI CONNECTION

It is possible to follow 2 methods to connect the device to WiFi.

METHOD 1: CONNECT VIA BLUETOOTH

- Activate Bluetooth on your cell phone or other device.
- When the WIFI indicator flashes, open the "Smart Life" APP, the unit will be automatically connected via Bluetooth.

METHOD 2: CONNECTION VIA APP

- When the WIFI indicator flashes, select Add device / Large appliances / Portable air conditioners and follow the instructions on the display.
- Check the status of the WIFI indicator and choose the correct status.
- If the Wifi indicator flashes quickly, you can connect directly.
- If the WIFI indicator flashes slowly, press "Go to connection" to connect the wifi named "SmartLife-XXXX"

Remarks: Once the appliance has been correctly connected, the WIFI indicator lights up. Now you can use the appliance via the App. Press and hold the Timer button for about 5 seconds, the device disconnects, the WIFI indicator turns off.

CARE AND MAINTENANCE

WARNING!

Prior to carrying out any cleaning or maintenance, unplug the unit from the power socket.

1. Air filter cleaning

The air filter must be checked at least once every two weeks of operation. Operation with dirty or clogged filter always causes a decrease in the efficiency of the air conditioner and can cause serious problems. To remove the upper filter, unhook the rear grille and then remove the filter, pulling it gently. Use a vacuum cleaner to remove dust. If this is not sufficient, wash the filter with warm water and possibly neutral detergent, rinse it with cold water and let it dry naturally before putting it back in its place. Once the filter has been reinserted, close the grille and resume using the air conditioner.

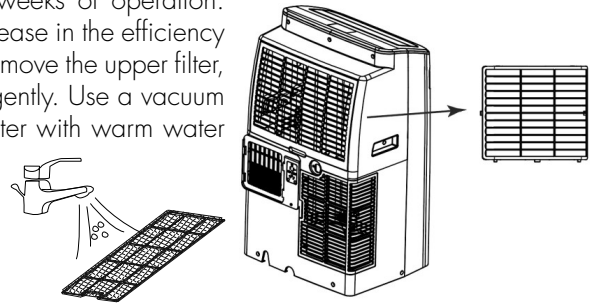

2. Cleaning of the casing

Use a soft, damp cloth to clean the outside of the air conditioner. Do not use too hot water, solvents, petrol or other aggressive chemical compounds, talcum powder and brushes: they could damage the surface or the color of the case. To remove any stains, use warm water with a little neutral detergent. Do not pour water on the air conditioner to clean it: this could damage the internal components or cause a short circuit.

3. Storage

When you do not envisage using the air conditioner for a long time, clean the filters before storing it away. Keep the appliance in a vertical position at all times. Do not place any heavy objects on the top and, if possible, protect the air conditioner with a plastic sheet.

4. Transport

Transport the air conditioner in an upright position if possible. If this is not possible, lay him on his right side; when you arrive at your destination, immediately put the appliance back in the vertical position and wait at least 4 hours before using it for cooling.

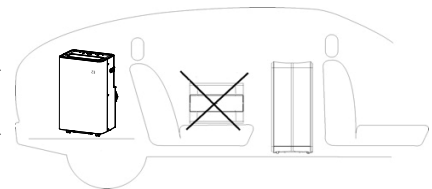

5. For complete safety, regularly check the condition of the power cord; should it be damaged through use, contact the Service Centre to replace it.

TIPS FOR MAXIMISING COMFORT AND MINIMISING CONSUMPTION

CHECK:

- the unit's extraction and delivery grilles are always unobstructed;
- the air filters are always clean: a dirty filter will decrease the passage of air and thus reduce the unit performance;
- the doors and windows are closed, to avoid infiltration of unconditioned air;
- the flexible hose is correctly positioned, without folds or sharp bends;
- the room temperature is above 16 °C for the cooling mode, 5°C for heating and 17 °C for dehumidification mode.

REGULATION (UE) No. 573/2024 - F-GAS

The unit contains R290, a natural greenhouse gas with global warming potential (GWP) = 0,02 - Kg. 0,200 = 0,000004 Tons CO₂ equiv. Do not release R290 into the atmosphere.



INFORMATION FOR THE CORRECT DISPOSAL OF THE PRODUCT IN ACCORDANCE WITH EUROPEAN DIRECTIVE 2012/19/EU

This appliance may not be scrapped with domestic waste at the end of its life cycle. We call your attention to the crucial role played by the consumer in the re-use, recycling and other forms of recovery of such waste. The appliance must be scrapped by a sorted waste disposal centre or by returning it to the retailer (no charge is levied for this service), when you purchase a new equivalent appliance. Sorted disposal of electric and electronic equipment prevents the negative effects on the environment and human health resulting from improper scrapping, and also allows the materials from which it is made to be recovered and recycled, with significant savings in terms of energy and resources. The sorted disposal requirement is indicated by the crossed waste bin label affixed to the appliance.

SPECIALIST'S MANUAL

Aptitude requirement for maintenance man (repairs should be done only by specialists).

- Any person who is involved with working on or breaking into a refrigerant circuit should hold a current valid certificate from an industry-accredited assessment authority, which authorises their competence to handle refrigerants safely in accordance with an industry recognised assessment specification.
- Servicing shall only be performed as recommended by the equipment manufacturer. Maintenance and repair requiring the assistance of other skilled personnel shall be carried out under the supervision of the person competent in the use of flammable refrigerants.

Safety preparation work

The maximum refrigerant charge amount is shown on the following table a
(Note: Please refer to the nameplate for the charging quantity of R290).

Room area (m ²)	4	11	15
Maximum charge (kg)	<0.152	0.225	0.304

Table a - Maximum charge (kg)

Security checks

Prior to beginning work on systems containing flammable refrigerants, safety checks are necessary to ensure that the risk of ignition is minimised. For repair to the refrigerating system, the following precautions shall be complied with prior to conducting work on the system.

- **Work procedure**
Work shall be undertaken under a controlled procedure so as to minimise the risk of a flammable gas or vapour being present while the work is being performed.
- **General work area**
All maintenance staff and others working in the local area shall be instructed on the nature of work being carried out. Work in confined spaces shall be avoided. The area around the workspace shall be sectioned off. Ensure that the conditions within the area have been made safe by control of flammable material.
- **Checking for presence of refrigerant**
The area shall be checked with an appropriate refrigerant detector prior to and during work, to ensure the technician is aware of potentially toxic or flammable atmospheres. Ensure that the leak detection equipment being used is suitable for use with all applicable refrigerants, i.e. non-sparking, adequately sealed or intrinsically safe.
- **Presence of fire extinguisher**
If any hot work is to be conducted on the refrigeration equipment or any associated parts, appropriate fire extinguishing equipment shall be available to hand. Have a dry powder or CO₂ fire extinguisher adjacent to the charging area.
- **No ignition sources**
No person carrying out work in relation to a refrigeration system which involves exposing any pipe work shall use any sources of ignition in such a manner that it may lead to the risk of fire or explosion. All possible ignition sources, including cigarette smoking, should be kept sufficiently far away from the site of installation, repairing, removing and disposal, during which refrigerant can possibly be released to the surrounding space. Prior to work taking place, the area around the equipment is to be surveyed to make sure that there are no flammable hazards or ignition risks. "No Smoking" signs shall be displayed.
- **Ventilated area**
Ensure that the area is in the open or that it is adequately ventilated before breaking into the system or conducting any hot work. A degree of ventilation shall continue during the period that the work is carried out. The ventilation should safely disperse any released refrigerant and preferably expel it externally into the atmosphere.
- **Checks to the refrigeration equipment**
Where electrical components are being changed, they shall be fit for the purpose and the correct specification. At all times the manufacturer's maintenance and service guidelines shall be followed. If in doubt, consult the manufacturer's technical department for assistance.

The following checks shall be applied to installations using flammable refrigerants:

- The actual refrigerant charge is in accordance with the room size within which the refrigerant containing parts are installed;
- The ventilation machinery and outlets are operating adequately and are not obstructed;
- If an indirect refrigerating circuit is being used, the secondary circuit shall be checked for the presence of refrigerant;
- Marking to the equipment continues to be visible and legible. Markings and signs that are illegible shall be corrected;
- Refrigeration pipe or components are installed in a position where they are unlikely to be exposed to any substance which may corrode refrigerant containing components, unless the components are constructed of materials which are inherently resistant to being corroded or are suitably protected against being so corroded.

- **Checks to electrical devices**

Repair and maintenance to electrical components shall include initial safety checks and component inspection procedures. If a fault exists that could compromise safety, then no electrical supply shall be connected to the circuit until it is satisfactorily dealt with. If the fault cannot be corrected immediately but it is necessary to continue operation, an adequate temporary solution shall be used. This shall be reported to the owner of the equipment so all parties are advised.

Initial safety checks shall include:

- That capacitors are discharged: this shall be done in a safe manner to avoid possibility of sparking;
- That no live electrical components and wiring are exposed while charging, recovering or purging the system;
- That there is continuity of earth bonding.

- **Repairs to sealed components**

During repairs to sealed components, all electrical supplies shall be disconnected from the equipment being worked upon prior to any removal of sealed covers, etc. If it is absolutely necessary to have an electrical supply to equipment during servicing, then a permanently operating form of leak detection shall be located at the most critical point to warn of a potentially hazardous situation. Particular attention shall be paid to the following to ensure that by working on electrical components, the casing is not altered in such a way that the level of protection is affected. This shall include damage to cables, excessive number of connections, terminals not made to original specification, damage to seals, incorrect fitting of glands, etc.

- Ensure that the apparatus is mounted securely.
- Ensure that seals or sealing materials have not degraded to the point that they no longer serve the purpose of preventing the ingress of flammable atmospheres. Replacement parts shall be in accordance with the manufacturer's specifications.

NOTE: the use of silicon sealant can inhibit the effectiveness of some types of leak detection equipment. Intrinsically safe components do not have to be isolated prior to working on them.

- **Repair to intrinsically safe components**

Do not apply any permanent inductive or capacitance loads to the circuit without ensuring that this will not exceed the permissible voltage and current permitted for the equipment in use. Intrinsically safe components are the only types that can be worked on while live in the presence of a flammable atmosphere. The test apparatus shall bear the correct rating. Replace components only with parts specified by the manufacturer. Other parts may result in the ignition of refrigerant in the atmosphere from a leak.

- **Cabling**

Check that cabling will not be subject to wear, corrosion, excessive pressure, vibration, sharp edges or any other adverse environmental effects. The check shall also take into account the effects of aging or continual vibration from sources such as compressors or fans.

- **Detection of flammable refrigerants**

Under no circumstances shall potential sources of ignition be used in the searching for or detection of refrigerant leaks. A halide torch (or any other detector using a naked flame) shall not be used.

- **Leak detection methods**

The following leak detection methods are deemed acceptable for all refrigerant systems. Electronic leak detectors may be used to detect refrigerant leaks but, in the case of flammable refrigerants, the sensitivity may not be adequate, or may need re-calibration. (Detection equipment shall be calibrated in a refrigerant-free area.) Ensure that the detector is not a potential source of ignition and is suitable for the refrigerant used. Leak detection equipment shall be set at a percentage of the LFL of the refrigerant and shall be calibrated to the refrigerant employed, and the appropriate percentage of gas (25 % maximum) is confirmed. Leak detection fluids are suitable

for use with most refrigerants but the use of detergents containing chlorine shall be avoided as the chlorine may react with the refrigerant and corrode the copper pipe-work. If a leak is suspected, all naked flames shall be removed/extinguished. If a leakage of refrigerant is found which requires brazing, all of the refrigerant shall be recovered from the system, or isolated (by means of shut off valves) in a part of the system remote from the leak. For appliances containing flammable refrigerants, oxygen free nitrogen (OFN) shall then be purged through the system both before and during the brazing process.

- **Removal and evacuation**

When breaking into the refrigerant circuit to make repairs or for any other purpose conventional procedures shall be used. However, for flammable refrigerants it is important that best practice is followed since flammability is a consideration.

The following procedure shall be adhered to:

- remove refrigerant;
- purge the circuit with inert gas; evacuate;
- purge again with inert gas;
- open the circuit by cutting or brazing.

The refrigerant charge shall be recovered into the correct recovery cylinders. For appliances containing flammable refrigerants, the system shall be flushed with OFN to render the unit safe. This process may need to be repeated several times. Compressed air or oxygen shall not be used for purging refrigerant systems. For appliances containing flammable refrigerants, flushing shall be achieved by breaking the vacuum in the system with OFN and continuing to fill until the working pressure is achieved, then venting to atmosphere, and finally pulling down to a vacuum. This process shall be repeated until no refrigerant is within the system. When the final OFN charge is used, the system shall be vented down to atmospheric pressure to enable work to take place. This operation is absolutely vital if brazing operations on the pipe-work are to take place. Ensure that the outlet for the vacuum pump is not close to any ignition sources and that ventilation is available.

- **Charging procedures**

In addition to conventional charging procedures, the following requirements shall be followed.

- Ensure that contamination of different refrigerants does not occur when using charging equipment. Hoses or lines shall be as short as possible to minimise the amount of refrigerant contained in them.
- Cylinders shall be kept upright.
- Ensure that the refrigeration system is earthed prior to charging the system with refrigerant.
- Label the system when charging is complete (if not already).
- Extreme care shall be taken not to overfill the refrigeration system.

Prior to recharging the system, it shall be pressure-tested with the appropriate purging gas. The system shall be leak-tested on completion of charging but prior to commissioning. A follow up leak test shall be carried out prior to leaving the site.

- **Decommissioning**

Before carrying out this procedure, it is essential that the technician is completely familiar with the equipment and all its detail. It is recommended good practice that all refrigerants are recovered safely. Prior to the task being carried out, an oil and refrigerant sample shall be taken in case analysis is required prior to re-use of reclaimed refrigerant. It is essential that electrical power is available before the task is commenced.

1. Become familiar with the equipment and its operation.
2. Isolate system electrically.
3. Before attempting the procedure, ensure that:
 - mechanical handling equipment is available, if required, for handling refrigerant cylinders;
 - all personal protective equipment is available and being used correctly;
 - the recovery process is supervised at all times by a competent person;
 - recovery equipment and cylinders conform to the appropriate standards.
4. Pump down refrigerant system, if possible.
5. If a vacuum is not possible, make a manifold so that refrigerant can be removed from various parts of the system.
6. Make sure that cylinder is situated on the scales before recovery takes place.
7. Start the recovery machine and operate in accordance with manufacturer's instructions.
8. Do not overfill cylinders. (No more than 80% volume liquid charge).
9. Do not exceed the maximum working pressure of the cylinder, even temporarily.
10. When the cylinders have been filled correctly and the process completed, make sure that the cylinders and the equipment are removed from site promptly and all isolation valves on the equipment are closed off.
11. Recovered refrigerant shall not be charged into another refrigeration system unless it has been cleaned and checked.

- **Labelling**

Equipment shall be labelled stating that it has been de-commissioned and emptied of refrigerant. The label shall be dated and signed. For appliances containing flammable refrigerants, ensure that there are labels on the equipment stating the equipment contains flammable refrigerant.

- **Recovery**

When removing refrigerant from a system, either for servicing or decommissioning, it is recommended good practice that all refrigerants are removed safely. When transferring refrigerant into cylinders, ensure that only appropriate refrigerant recovery cylinders are employed. Ensure that the correct number of cylinders for holding the total system charge are available. All cylinders to be used are designated for the recovered refrigerant and labelled for that refrigerant (i.e. special cylinders for the recovery of refrigerant). Cylinders shall be complete with pressure-relief valve and associated shut-off valves in good working order. Empty recovery cylinders are evacuated and, if possible, cooled before recovery occurs. The recovery equipment shall be in good working order with a set of instructions concerning the equipment that is at hand and shall be suitable for the recovery of all appropriate refrigerants including, when applicable, flammable refrigerants. In addition, a set of calibrated weighing scales shall be available and in good working order. Hoses shall be complete with leak-free disconnect couplings and in good condition. Before using the recovery machine, check that it is in satisfactory working order, has been properly maintained and that any associated electrical components are sealed to prevent ignition in the event of a refrigerant release. Consult manufacturer if in doubt. The recovered refrigerant shall be returned to the refrigerant supplier in the correct recovery cylinder, and the relevant waste transfer note arranged. Do not mix refrigerants in recovery units and especially not in cylinders. If compressors or compressor oils are to be removed, ensure that they have been evacuated to an acceptable level to make certain that flammable refrigerant does not remain within the lubricant. The evacuation process shall be carried out prior to returning the compressor to the suppliers. Only electric heating to the compressor body shall be employed to accelerate this process. When oil is drained from a system, it shall be carried out safely.



improve your life

www.argoclima.com

Argoclima assumes no responsibility for any errors or inaccuracies in the content of this manual and reserves the right to make to this, at any time and without notice, any changes deemed appropriate for any technical or commercial need.